

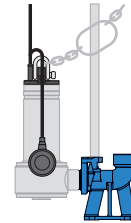





SYSTEM OVERVIEW



One pedestal-mounted automatic Xylem Domo stainless steel pump with guide rails and lifting chains

-  2" Class E PVC pipework
-  2" brass valves
-  63 mm MDPE discharge
-  110 mm inlet
-  50 mm cable duct
-  50 mm vent duct

Pumps by

xylem
Let's Solve Water



Access cover, solid top, locking, galvanised steel, PP frame, FACTA A

A fully automatic twin pump packaged pumping station suitable for pumping grey and foul water to a higher level when gravity drainage is not possible or economical to install.

The system provides up to 700 litre storage capacity depending inlet depth. It is ideal for accepting waste from an extension, outbuilding, basement or similar.

A stainless steel Xylem Domo pump provides reliable and effective pumping of grey and foul water.

It can accept foul waste if the property also has another method of removing foul waste. Contact our Sales Team if you require a foul water packaged pumping station to serve the whole property.

The system comprises our award-winning polyethylene chamber, internal Class E PVC pipework and fittings, brass valves, one pedestal-mounted automatic pump, stainless steel guide rails and lifting chains, and an external compression adaptor for discharge to 63 mm OD MDPE. A pedestrian duty 600 mm x 450 mm solid top access cover is included.

It is simple to install as inlets can be positioned to your site's requirements. Inlet information to be supplied at time of order, or they can be drilled on site.

The system is built to last and designed to be easy to service.

KEY FEATURES

- Channel impellor for high flow and solids handling
- Up to 700 litres storage capacity
- 60° benching
- Compact chamber for limited space installations
- Ideal for accepting waste from an extension, outbuilding, basement or similar application
- 600 mm x 450 mm pedestrian duty access cover
- Variable inlet positions to suit site
- A range of alarms and remote alerts are available
- Quick and simple to install

SPECIFICATIONS

This system complies with:

- BS EN 12050-2:2015 Wastewater lifting plants for buildings and sites. Lifting plants for faecal-free wastewater.
- BS EN 12050-3:2015 Wastewater lifting plants for buildings and sites. Lifting plants for limited applications.

ACCESSORIES

Inlay access cover

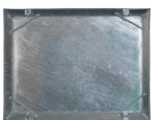

106985

Additional inlet



110 mm 50 mm
107035 107034

HIGH LEVEL ALARM (RECOMMENDED)



AquaSafe Alarm

High level alarm
HLA recorded alert
Service due alert
Volt-free contacts for BMS
Alarm battery backup

106993

EXAMPLE INSTALLATION

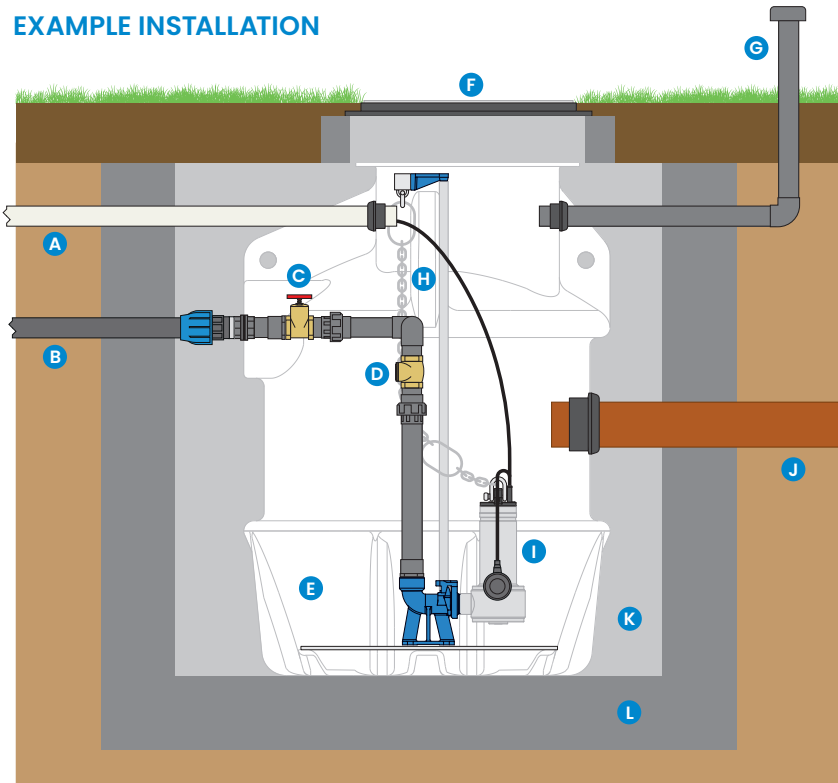

- | | |
|--|---------------------------------------|
| A 50 mm cable duct | G 50 mm vent duct |
| B 63 mm OD MDPE discharge | H Guide rail and lifting chain |
| C 2" brass gate valve | I Choice of automatic pumps |
| D 2" brass swing check valve | J 100 mm ID inlet |
| E Tank-grade polyethylene chamber | K Concrete backfill |
| F Access cover 600 mm x 450 mm | L Reinforced concrete sump |

PUMP SPECIFICATIONS

Pump	Domo 15
Number of pumps	One
Impellor type	Channel
Control	Automatic
Power supply	230 VAC
Rated current	7.0 A
Motor rating (P2)	750 W
Discharge size	2"
Free passage	50 mm
Max. vertical output	12 m
Max. flow rate	10.0 l/s
Max liquid temp.	<35 °C
Cable length	10 m
Weight	15.3 kg

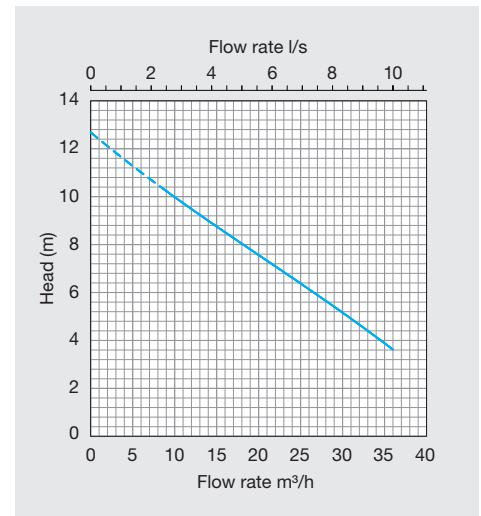

CHAMBER DIMENSIONS

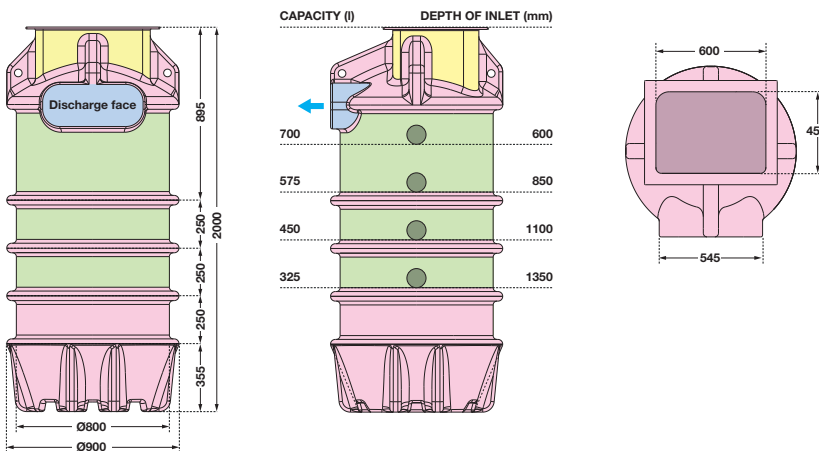

Permitted connection positions

Discharge only	Inlet location allowed	Cable ducts and vents only	No drilling allowed
----------------	------------------------	----------------------------	---------------------

Capacities indicative from lowest inlet invert.

CHAMBER SPECIFICATIONS

Internal pipework	2" OD Class E PVC
Discharge pipework	63 mm OD MDPE
Lifting eyes	4 no
Max. storage capacity	700 litres
Chamber material	Tank-grade polyethylene
Dimensions (Ø x H)	900 x 2000 mm
Clear opening	600 x 450 mm

In accordance with Tricel's normal policy of product development these specifications are subject to change without notice. Tricel (Killarney) Unlimited Company trading as Tricel.