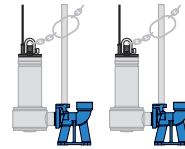
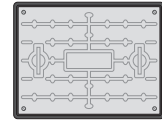

Illustration shows FoulPro 1250 Twin.

SYSTEM OVERVIEW



Two stainless steel pedestal mounted manual pumps



Access cover, solid top, locking, galvanised steel, PP frame, FACTA A

2" Class E PVC pipework

110 mm inlet

2" brass valves

110 mm cable duct

63 mm MDPE discharge

110 mm vent

Control panel with 3 floats & counterweights

Pumps by
xylem
Let's Solve Water

PRODUCT SUMMARY

- Suitable for foul and grey water
- Structurally-reinforced tank-grade HDPE chamber
- Two stainless steel pedestal mounted manual pumps
- Vortex impellor for high flow rates
- IP54 control panel with 3 sump float switches and counterweights
- 600 mm x 450 mm chamber clear opening
- Access cover, 600 x 450 mm clear opening, locking, galvanised steel top with polypropylene frame, single seal, FACTA A (pedestrian duty)
- Inlets, vent and cable duct can be drilled on site

PUMP SPECIFICATIONS (PER PUMP)

Rated current	5.9 A
P2 motor rating	750 W
RCBO Type-C rating	10 A
Max. head	7.7 m
Max. flow rate	6.7 l/s
Discharge size	2"
Free passage	50 mm
Pump cable length	10 m

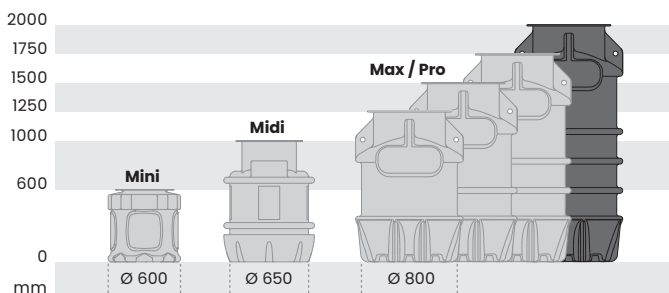
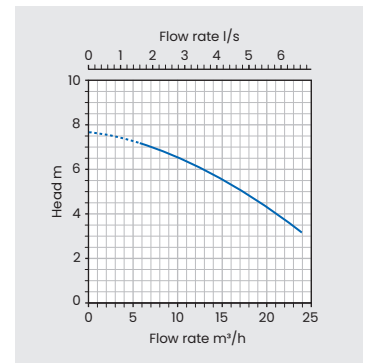

Distance pumped at 1.8 l/s (63 mm OD MDPE)

Static head m	Distance m	Static head m	Distance m
2.0	175	5.0	70
3.0	140	6.0	35
4.0	105	7.0	0

Static head is measured from the pump not chamber discharge.

In accordance with Tricel's normal policy of product development these specifications are subject to change without notice. Tricel (Killarney) Unlimited Company trading as Tricel.

KEY FEATURES

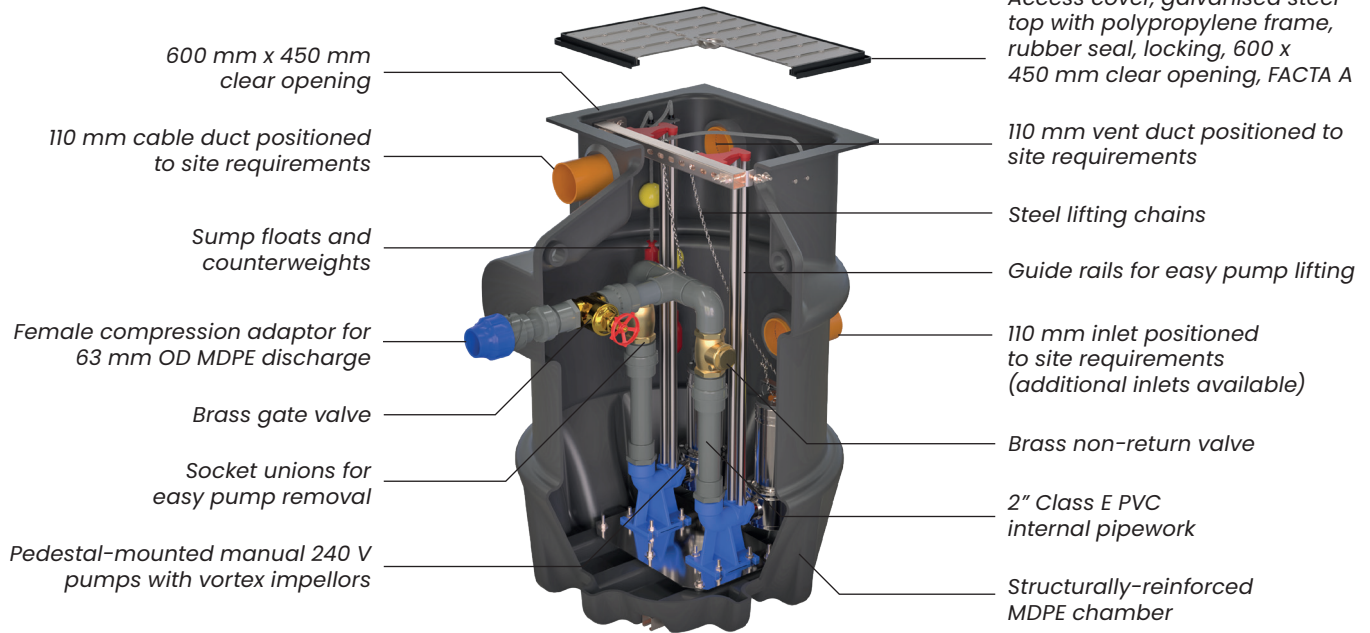
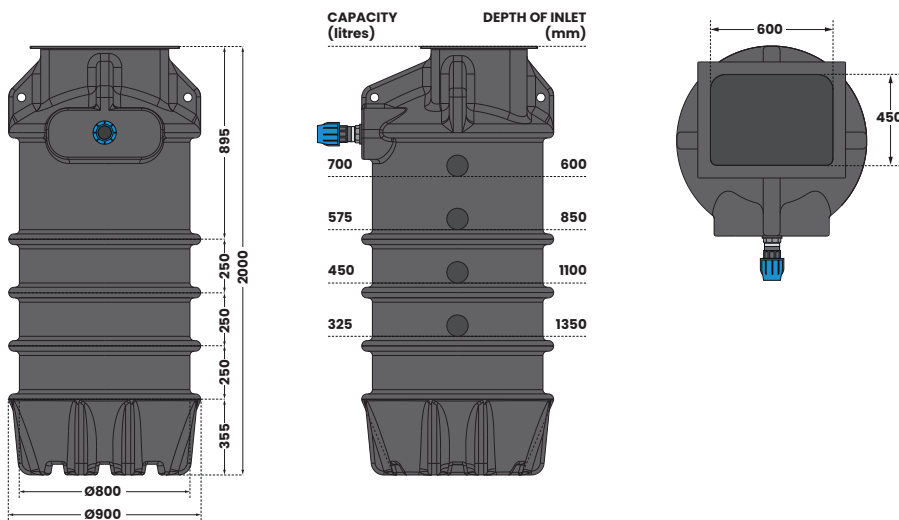

Illustration shows FoulPro 1250 Twin.

DIMENSIONS



Internal pipework	2" OD Class E PVC
Discharge pipework	2" OD Class E PVC
Chamber material	Tank-grade HDPE
Lifting eyes	Yes

Indicative capacity from inlet invert

RECOMMENDED ACCESSORIES

Inlay access cover 600 x 450 mm

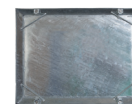

106985

Additional connections

110 mm 50 mm



107034

107035